



RWD32



RWD82

Universal Controller

For comfort control in HVAC&R-Systems

RWD32
RWD82

- Standalone electronic temperature controller with P or PI response
- Operating voltage in accordance to type AC 230 V or AC 24 V
- Control application selectable via Application Number
- Active input scale can be selectable
- Two universal inputs for Ni 1000, Pt 1000 temperature sensors and DC 0...10 V signals
- Unit can be set as °C, °F, % or no specified unit
- One 3-position output or two two-position outputs, direct or reverse action
- One digital input for day/night changeover
- Entering or changing of all data via operating buttons on the controller, possible without additional tools
- PC connection for downloading canned applications via the software tool

Use

The universal controllers are intended for Heating, Ventilating, Air-Conditioning and Refrigeration in comfort control plants. It can be mounted in a control panel or in the ARG62.21/ARG62.22 housing on ducts, walls and in plant rooms.

Measurement and control of temperature, relative humidity, absolute humidity, enthalpy, pressure differential, volumetric airflow and indoor air quality. The input scale can be set from –100 units to 8,000 units.

Functions Summary

- Controller
Stand-alone controller with one 3-position or two 2-position (ON/OFF) outputs with independent adjustment on each sequence for direct acting and/or reverse acting. In 3-position operation, the controller exhibits PI response.
- Auxiliary selectable function
Universal input X2 for one of the following functions:
 - PI limiter function (absolute and relative)
 - Remote setpoint function
 - Cascade control function
 - Setpoint compensation
 - Winter/summer operation
 - Maximum priority
- Digital input D1 for setpoint changeover day/night

Type summary

<i>Inputs</i>		<i>Outputs (either)</i>		<i>Operating voltage</i>	<i>Type reference</i>
<i>Universal</i>	<i>Digital</i>	<i>3-position</i>	<i>2-position</i>		
2	1	1	2	AC 230 V	RWD32
2	1	1	2	AC 24 V	RWD82

Accessories

<i>Name</i>	<i>Type</i>
Protective small enclosure for wall mounting	ARG62.21
Protective big enclosure for wall mounting	ARG62.22
Software Tool	S3341A031EN0

Equipment combinations

The following Siemens units can be connected to RWD32 and RWD82 universal controllers.

<i>Units</i>	<i>Data sheet no.</i>
Sensor with LG-Ni 1000 temperature sensing element	17... to 19...
Sensor with Pt 1000 temperature sensing element	1846
Sensor with DC 0...10 V measuring signal	17... to 19...
Room temperature sensor with setpoint adjuster QAA25 or QAA25/AP	1721 / 1748
Remote setpoint adjusters FZA21.11 and FZA61.11	19...
Air damper actuators with 3-position input	46...
Valve actuators with 3-position input	45...

Other combinations with third-party units are possible, provided the input and output specifications match the RWD32 and RWD82.

Software Tool

A software tool for controller application selection and parameter adjustment is available. It is a user-friendly Windows® 95 (or above) based software tool which provides you a printout of the controller settings.

Functions

Controller type

The RWD32 and RWD82 are stand-alone universal controllers, which perform both primary and auxiliary control functions. The respective mode is defined by entering the corresponding configuration and setting parameters via the push buttons on the controller or the software tool.

Main functions

The RWD32 and RWD82 controllers can be programmed as follows:

- 2-position controller: Q1 and Q2 reverse and/or direct acting on each step
- 3-position controller: Q1 or Q2 reverse or direct acting

Dependent Control Loops

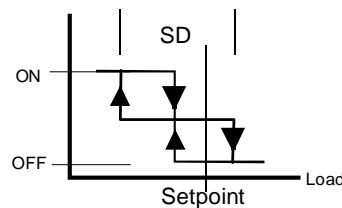

2 reverse acting sequences
(dependent loops)
(application No.: 10...19)

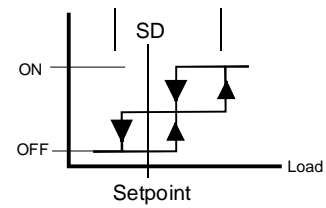

2 direct acting sequences
(dependent loops)
(application No.: 50...59)

Independent Control Loops

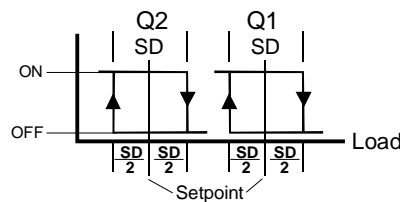

2 reverse acting sequences
(independent loops)
(application No.: 20...29)

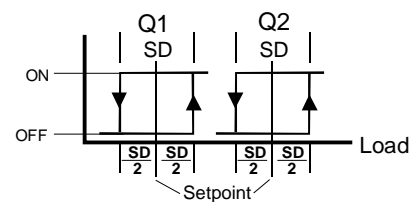

2 direct acting sequences
(independent loops)
(application No.: 60...69)

Reverse and Direct Acting Control Loops

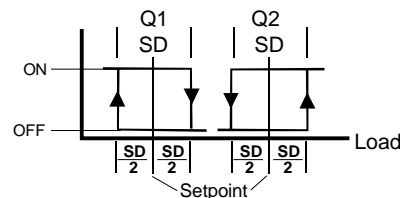

Reverse and direct acting sequences
(application No.: 40...49)

3-point Control Loop

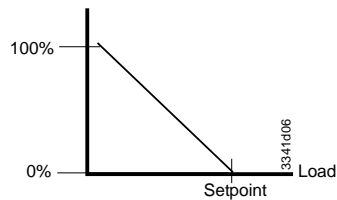

Reverse acting sequence
(application No.: 30...39)

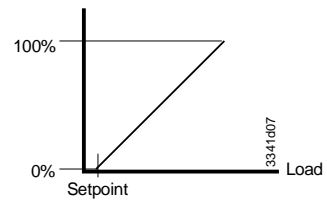

Direct acting sequence
(application No.: 70...79)

Universal input X1

The universal input X1 is used as the primary input for a LG-Ni 1000 temperature sensor, a Pt 1000 temperature sensor or a DC 0...10 V active input.

Universal input X2

The universal input X2 is used as the secondary input for a LG-Ni 1000 temperature sensor, a Pt 1000 temperature sensor, an active / passive remote setpoint transmitter or a DC 0...10 V active input.

Digital input D1

The digital input D1 is used to select the day/night changeover. Changeover occurs via potential-free contacts between D1 and M.

Digital outputs Q

Each output Q (Q1, Q2) can be configured for either reverse or direct acting.

Example

Ventilating plant with temperature control

- X1 Room temperature
- Q1 Heating, reverse action
- Q2 Cooling, direct action

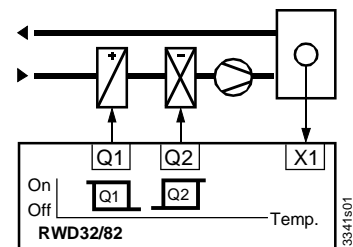

Auxiliary functions

One of the following auxiliary functions can be selected:

- PI limiter function (absolute and relative)
- Remote setpoint function
- Cascade control function
- Setpoint compensation
- Winter/summer operation
- Maximum priority

Additionally, the day and night operation mode is available.

PI limiter function

The limiter function with PI control enables absolute (or relative) maximum or minimum limitation of the supply air temperature (X2). When the value drops below or exceeds the limiter setpoint, the limiter function controls and takes priority over the main setpoint.

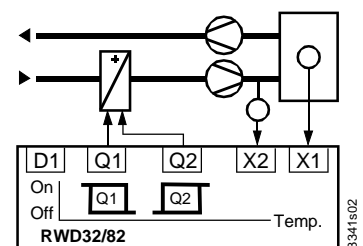

Remote setpoint

A remote setpoint transmitter (FZA21.11, QAA25 or QAA25/AP), connected to X2 and configured accordingly, enables setpoint adjustment. Active measurement from DC 0...10 V corresponding adjustable range from -100 to 8000. Passive measurement from 0...1000 Ω corresponding adjustable range from -100 to 8000.

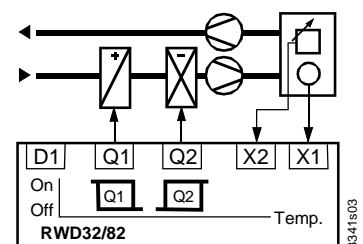

Cascade control

X2 Supply air temperature sensor

You can select the **PI/PI room/supply air temperature cascade control**. In this case, the virtual PI room temperature controller determines the setpoint within the limiter setpoints for the PI supply air temperature controller.

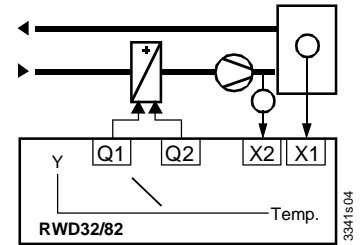

Maximum Priority

Maximum Priority, cooling

If the value (DC 0...10 V) of the input X2 is greater than the calculated output of the 3-point cooling sequence, the output will use the X2 input value as output value.

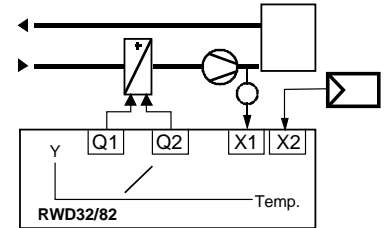

Setpoint compensation

The temperature setpoint X1 is shifted by the temperature as measured at sensor X2.

Configuration of the RWD32 or RWD82 defines the influence on setpoint X1.

The example shows the room air temperature setpoint as controlled by the outside temperature.

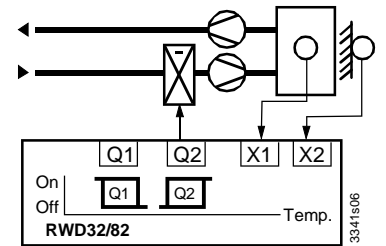

Winter/Summer operation

A digital switch or analog input between terminals X2 and M can be used to implement winter/summer changeover.

Digital changeover

When the contact is closed, summer operation is selected. Reverse acting output (Q1 only) is set to direct action (cooling).

Analog changeover

When the X2 input exceeds the setpoint, summer operation is selected. Reverse acting output (Q1 only) is set to direct action (cooling).

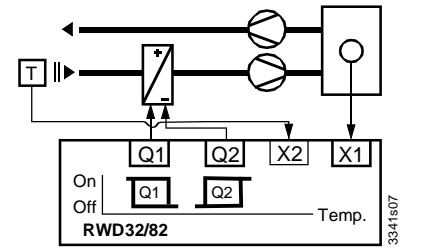

Day/night setpoint

A contact between terminals D1 and M can be used to implement setpoint changeover for day/night operation.

When the contact is open, the setpoints for day operation are selected.

When the contact is closed, the setpoints for night operation are selected.

During the night mode, the following auxiliary functions are disabled: remote setpoint, absolute/Relative limiter, setpoint compensation and maximum priority.

Housing

The RWD32 and the RWD82 universal controllers are as per DIN 43 880 Gr. 1 requirements.

Protective housing ARG62.21/ARG62.22

A protective housing is used to protect the controller when mounted outside a control panel, such as on ducts, walls and in plant rooms. Furthermore, the protective housing prevents inadvertent contact with voltage supplying parts such as the connecting terminals.

The RWD32 or RWD82 clips into the protective housing.

The cable entries are located at the top and the bottom of the protective housing.

The front has an opening for the LCD display and the programming buttons.

Mounting options

The RWD32 and RWD82 universal controllers can be mounted as follows:

- In a standard electrical control cabinet as per DIN 43 880
- Wall mounted in a protective housing
- Front mounting with standard available installation elements

Terminals

Plug-in screw terminals

Operating and display elements

The RWD32 and RWD82 are operated by the buttons on the controller front. Additional tools are not necessary. A 9-pin port is provided for optional programming via the software tool.

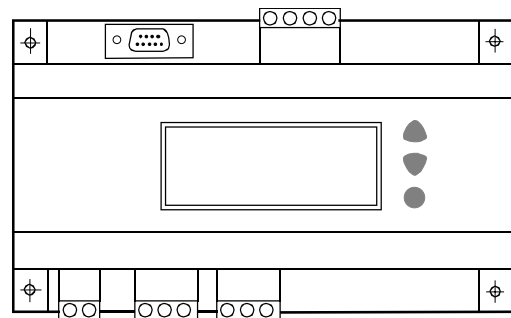

RWD32

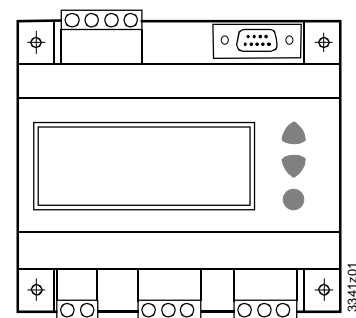

RWD82

LCD

The LCD shows the following information for normal operation:

- Current operating values (maximum 4 digits)
- Current setpoints (day/night)
- Application number
- Control sequencing diagram
- Auxiliary input value
- Selected auxiliary function

Operating buttons

The controller has three operating buttons for the following functions:

SELECT ●

The SELECT ● button is used to enter or save the value adjustment.



The ▲▼ operating buttons are used for viewing and adjusting parameters.

Configuration

To configure the controller, follow the instructions supplied with the controller.

Engineering notes

Intended use

Use this controller only for applications as described in the description on the title page (bold print) and the section "Use". Additionally, observe all conditions and restrictions imposed in this section and in "Technical data".



The sections marked with a warning symbol contain technical safety requirements and restrictions. Observe all of these warnings as they directly relate to the protection of person and equipment.

Installation notes

Observe all local installation and mounting regulations.

The RWD32 and RWD82 controllers can be mounted as follows:

- A On a top hat rail (EN60715, 35 × 7.5) at least 120 mm long for RWD82 and 170 mm long for RWD32
- B Wall mounted with 2 screws
- C Front mounted using standard elements, e.g.
 - 1 × top hat rail 150 mm long for RWD82 and 195 mm long for RWD32
 - 2 × hexagonal placeholders 50 mm washers and screws
- D In the ARG62.21/ARG62.22 protective housing

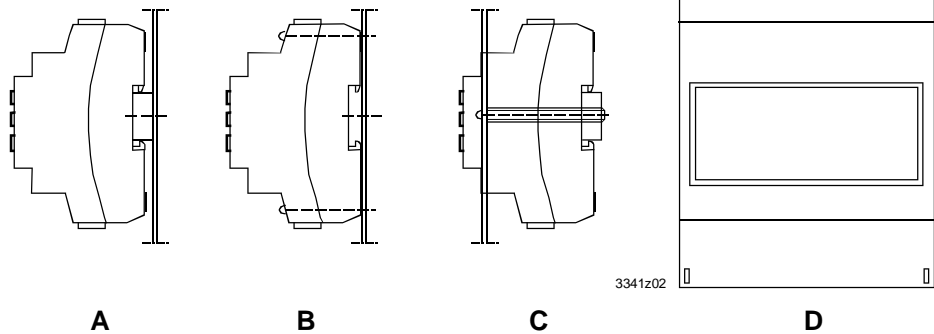

Electrical installation

Standard cables can be used for the controller. However, when mounting in an environment greatly exposed to EMI, use only shielded cables.



- The RWD32 is designed for AC 230 V operating voltage.
- The RWD82 is designed for AC 24 V operating voltage.

The low voltage must comply with the requirements for safety extra-low voltage (SELV) as per EN 60730.

Use safety insulating transformers with double insulation as per EN 60742; they must be designed for 100 % on-time.

When using several transformers in one system, the connection terminals G0 must be galvanically connected.

Supplying voltages above AC 24 V to low voltage connections may damage or destroy the controller or any other connected devices. Additionally, connections to voltages exceeding AC 42 V endanger personal safety.



Warning!

No internal line protection for supply lines to external consumers.

Risk of fire and injury due to short-circuits!

- Adapt the line diameters as per local regulations to the rated value of the installed overcurrent protection device.
- The power supply lines must have an external circuit breaker with a rated current of no more than 10 A.

Commissioning notes

A booklet is supplied with the RWD32 and RWD82 controller for commissioning.

Observe the following:

- The controller must be configured for plant-specific operation using standard application number.
- Plant specific fine tuning can be performed if required (refer to the commissioning booklet).
- Power supply to the controller and the connected devices must be guaranteed
- Values and settings entered remain available even on power failure.

Disposal



The devices are considered electronics devices for disposal in terms of European Directive 2012/19/EU and may not be disposed of as domestic waste.

- Dispose of the device via the channels provided for this purpose.
- Comply with all local and currently applicable laws and regulations.

Technical data

General data

 Power supply

Operating voltage RWD32	AC 230 V ±15 %
Operating voltage RWD82	AC 24 V ±20 %
Safety extra-low voltage (SELV) as per	EN 60730
Frequency RWD32	50 Hz/60 Hz
Frequency RWD82	50 Hz/60 Hz



No internal fuse.

External preliminary protection with max. C 10 A circuit breaker in the supply line required under all circumstances.

Power consumption

RWD32	6.5 VA
RWD82	3.5 VA

LCD

Actual and nominal values	4 digits
---------------------------	----------

Display resolution for (these values do not relate to the controller accuracy)

LG-Ni 1000	0.5 °C
Pt 1000	0.5 °C
Active sensor	Depends on the setting range

Environmental conditions

Transport	IEC 60721-3-2
Climatic conditions	Class 2K3
Temperature	-25...+70 °C
Humidity	<95 % r.h.
Mechanical conditions	Class 2M2

Environmental conditions

Operation	IEC 60721-3-3
Climatic conditions	Class 3K5
Temperature	0...+50 °C
Humidity	<95 % r.h.

IP code

Housing	IP 20 as per EN 60529
Front and with ARG62.21	IP 30 as per EN 60529
Front and with ARG62.22	IP 30 as per EN 60529

Norms and standards

EU Conformity (CE)	CE2T3341xx *)
RCM Conformity	CE2T3341en_c1 *)

Environmental compatibility

The product environmental declaration CE1E3341en02 *) contains data on environmentally compatible product design and assessments (RoHS compliance, materials composition, packaging, environmental benefit, disposal).

Terminals

Screw terminals for cables with	min. 0.5 mm dia. max. 2 x 1.5 mm ² or 2.5 mm ²
---------------------------------	---

Weight without packaging

RWD82	0.297 kg
RWD32	0.465 kg

Analog inputs X1, X2

LG-Ni 1000 Ω at 0 °C	Controller Measuring Range Max. cable length for dia. 0.6 mm	-50...+150 °C max. 300 m
Pt 1000 Ω at 0 °C	Controller Measuring Range Max. cable length for dia. 0.6 mm	-20...+180 °C max. 300 m
Analog voltages (for measured variables in °C, % or without unit)	Range Max. cable length for dia. 0.6 mm	DC 0...10 V corresponding to adjustable range from -100 to 8000 (°C, °F, % or no unit) max. 300 m
Remote setpoints X2	Range Max. cable length for dia. 0.6 mm	0...1000 Ω corresponding to adjustable range from -100 to 8000 (°C, °F, % or no unit) max. 300 m
Digital input D1	Polling voltage for control commands (D...M) Current consumption	DC 15 V < 15 mA
Digital outputs Q1, Q2	Relay contacts (potential-free) Voltage Maximum rating Minimum rating	AC 24...230 V AC 230 V, 4 A resistive, 3 A ind. (per relay terminal) DC 30 V, 4 A AC 19.2 V, 20 mA DC 5 V, 100 mA

*) The documents can be downloaded from <http://siemens.com/bt/download>.

Internal diagram

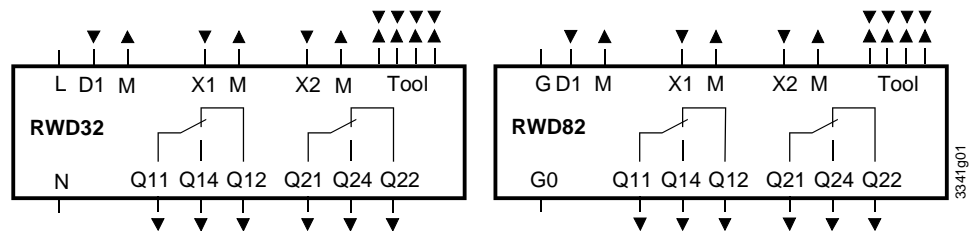

D1	Digital input
G, G0	AC 24 V supply (⚠ SELV AC 24 V Power supply)
L, N	AC 230 V supply
M	Ground (G0) for signal inputs and universal inputs
Q...	Digital output, various voltages permissible AC 24...230 V
X1	Signal input (main input: LG-Ni 1000, Pt 1000 and DC 0...10 V)
X2	Signal input (aux. Input: LG-Ni1000, Pt 1000, DC 0...10 V and 0...1000 Ω or DC 0...10 V remote setpoint)
Tool	Communication port for PC (9-pin plug)

Connection diagram

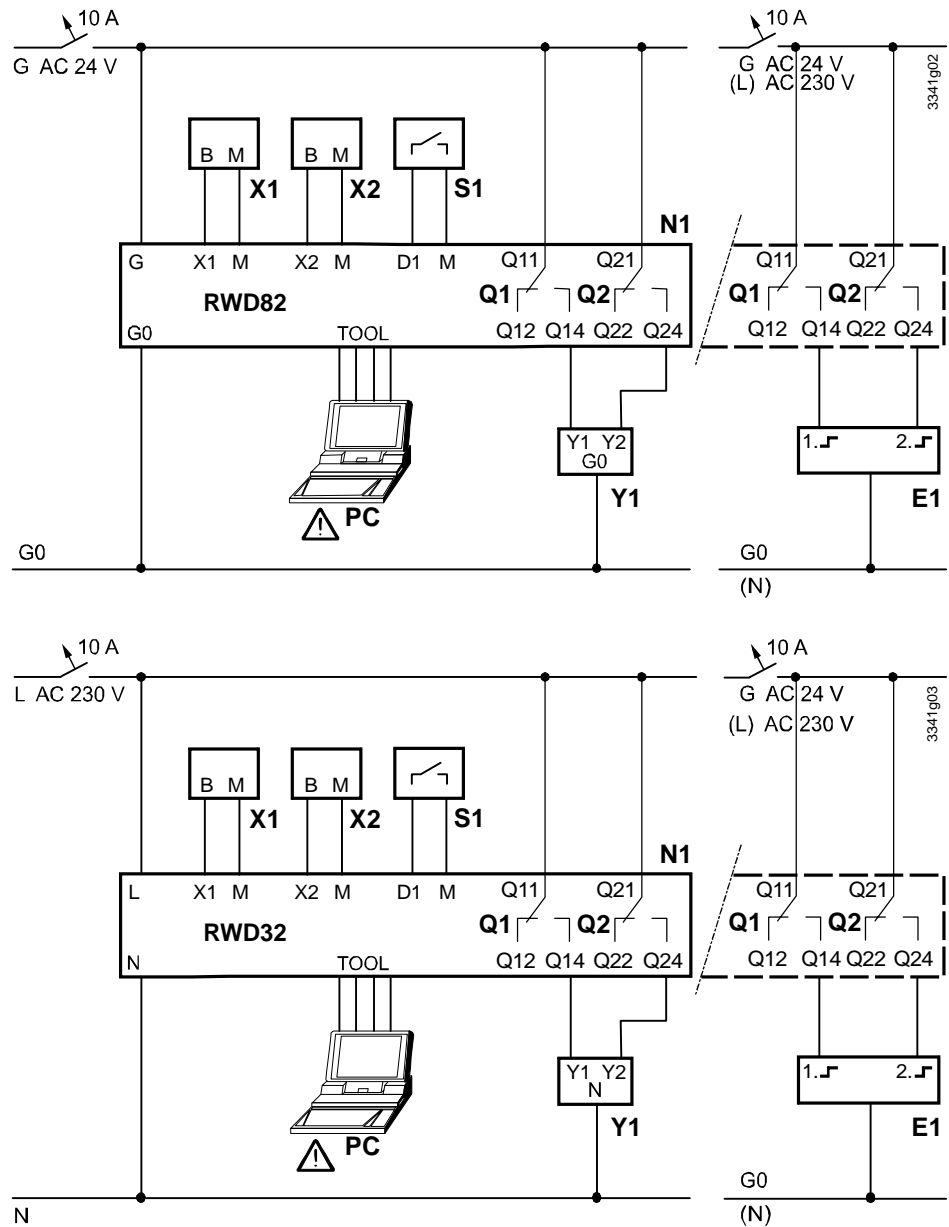

- E1 Electrical load 2-position control
- N1 RWD32/82 controllers
- PC Personal computer
- Q1/Q2 Potential-free relay contacts for 3-position or 2-position control in 2 steps
- S1 Time clock or switch
- X1 Main input (Termination G appears when X1 is an active sensor)
- X2 Auxiliary input or remote setpoint (Termination G appears when X2 is an active sensor)
- Y1 Actuator with 3-position control AC 24...230 V

Note 

Please note that if you use a DESKTOP computer, the TOOL signal ground is galvanically connected to G0 inside the controller. If the signal line of the computer is grounded to Earth, the G0 line after TOOL connection will be earthed as well.

This will change from SELV to a PELV.

Dimensions

RWD32

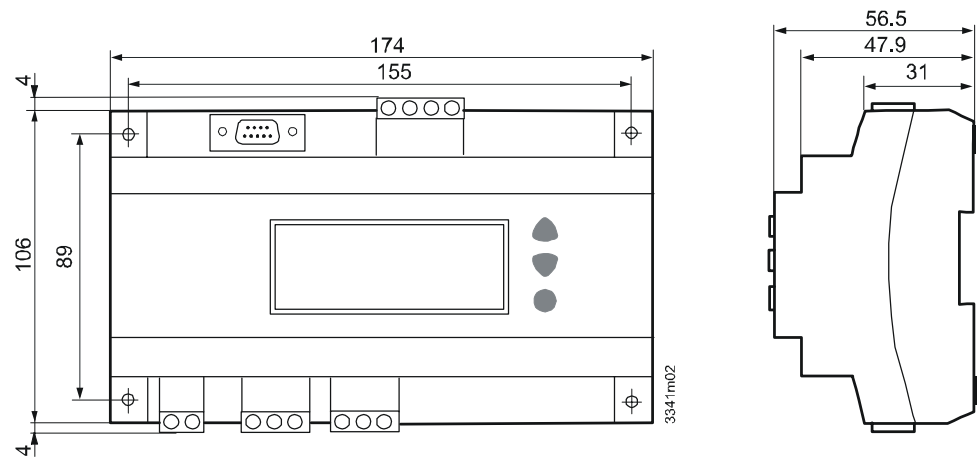

RWD82

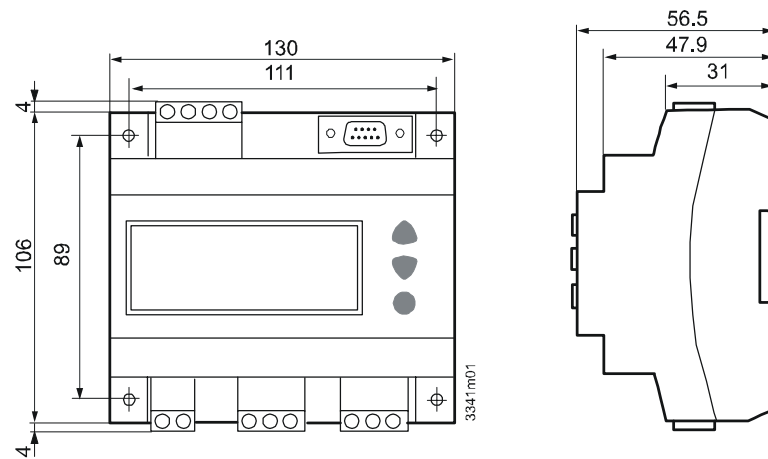

ARG62.21 / ARG62.22

